

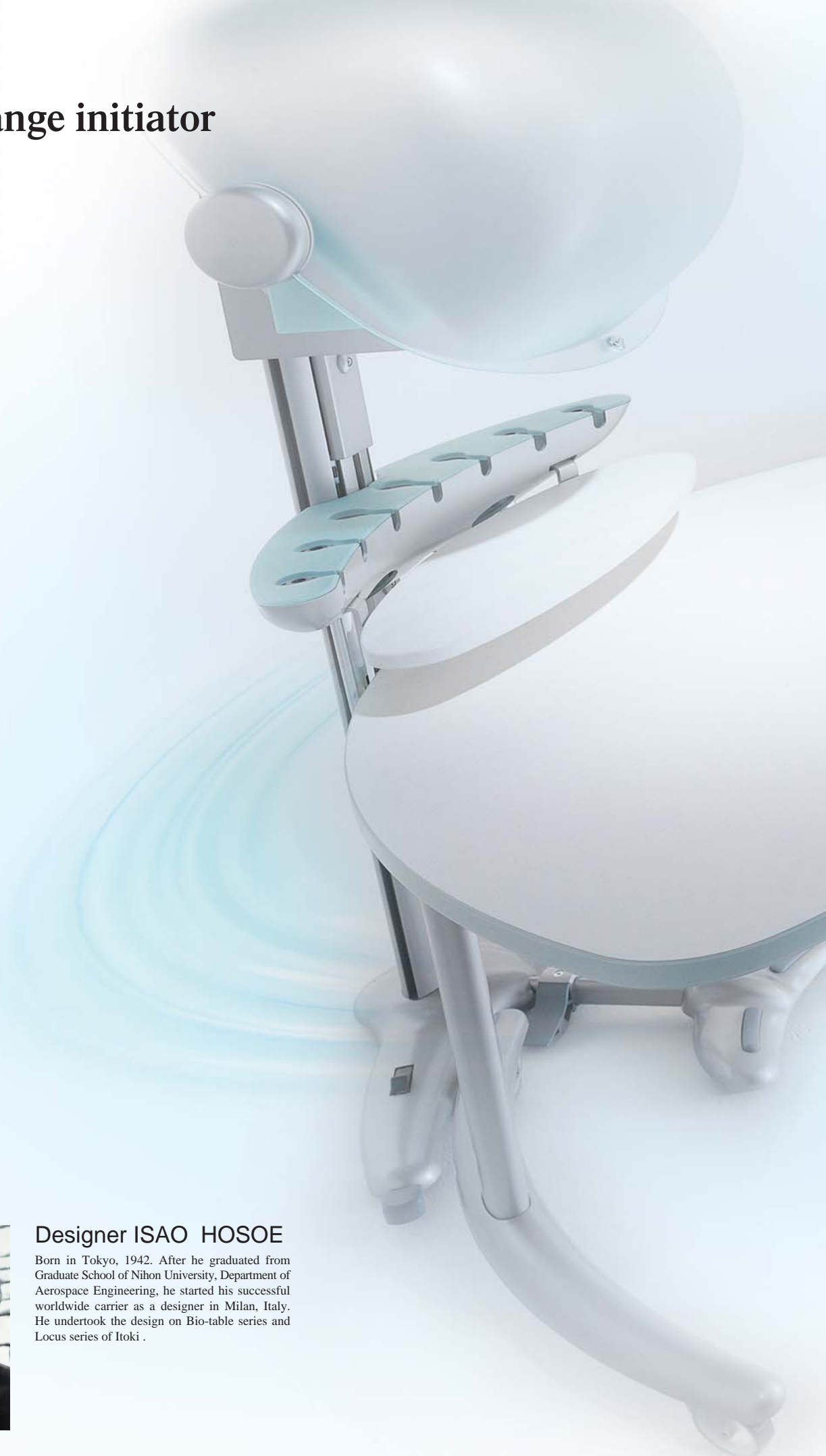

Be a change initiator



Designer ISAO HOSOE

Born in Tokyo, 1942. After he graduated from Graduate School of Nihon University, Department of Aerospace Engineering, he started his successful worldwide carrier as a designer in Milan, Italy. He undertook the design on Bio-table series and Locus series of Itoki .

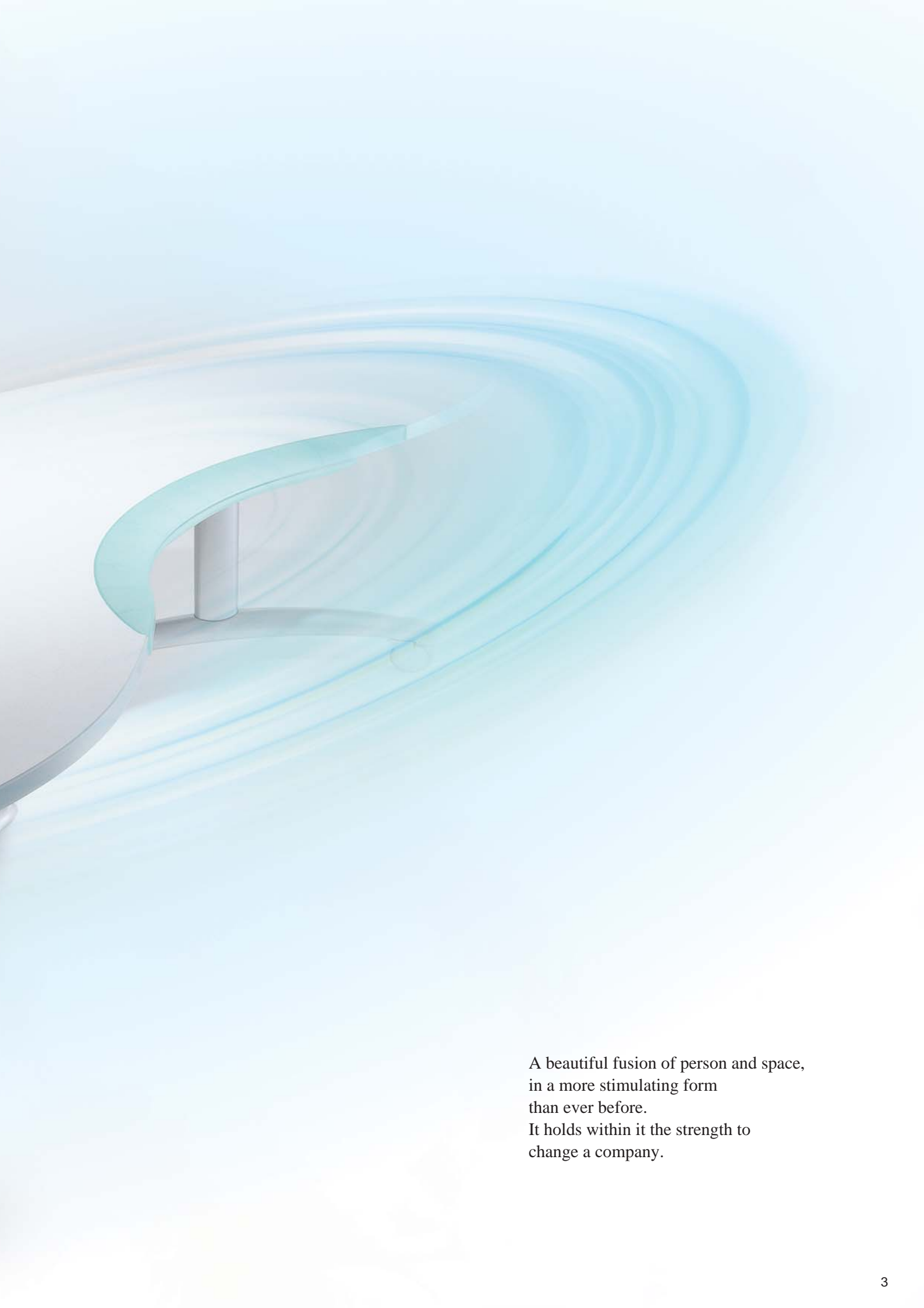

A beautiful fusion of person and space,
in a more stimulating form
than ever before.
It holds within it the strength to
change a company.

The ideal human-centered 1,600mm-diameter round module

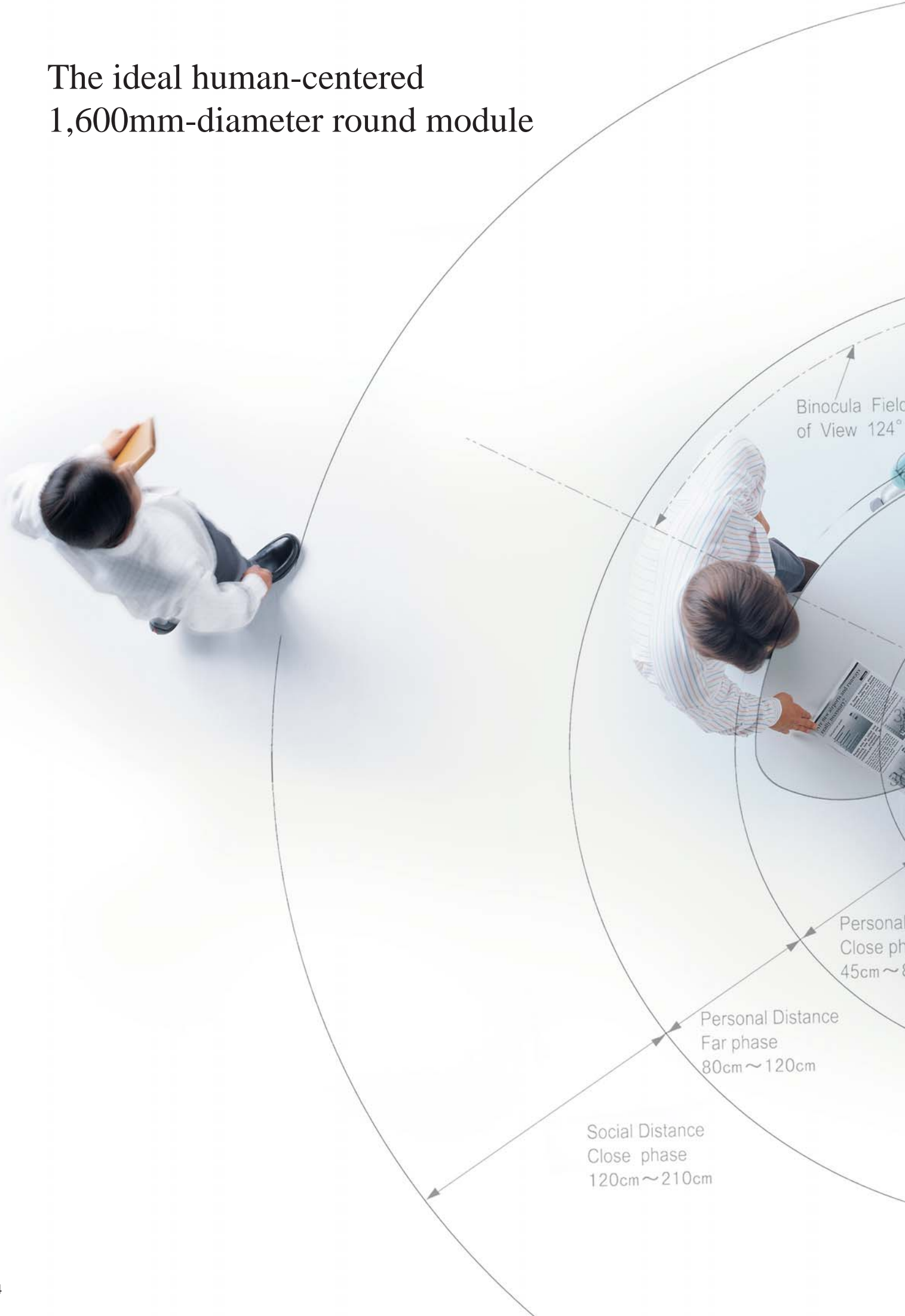

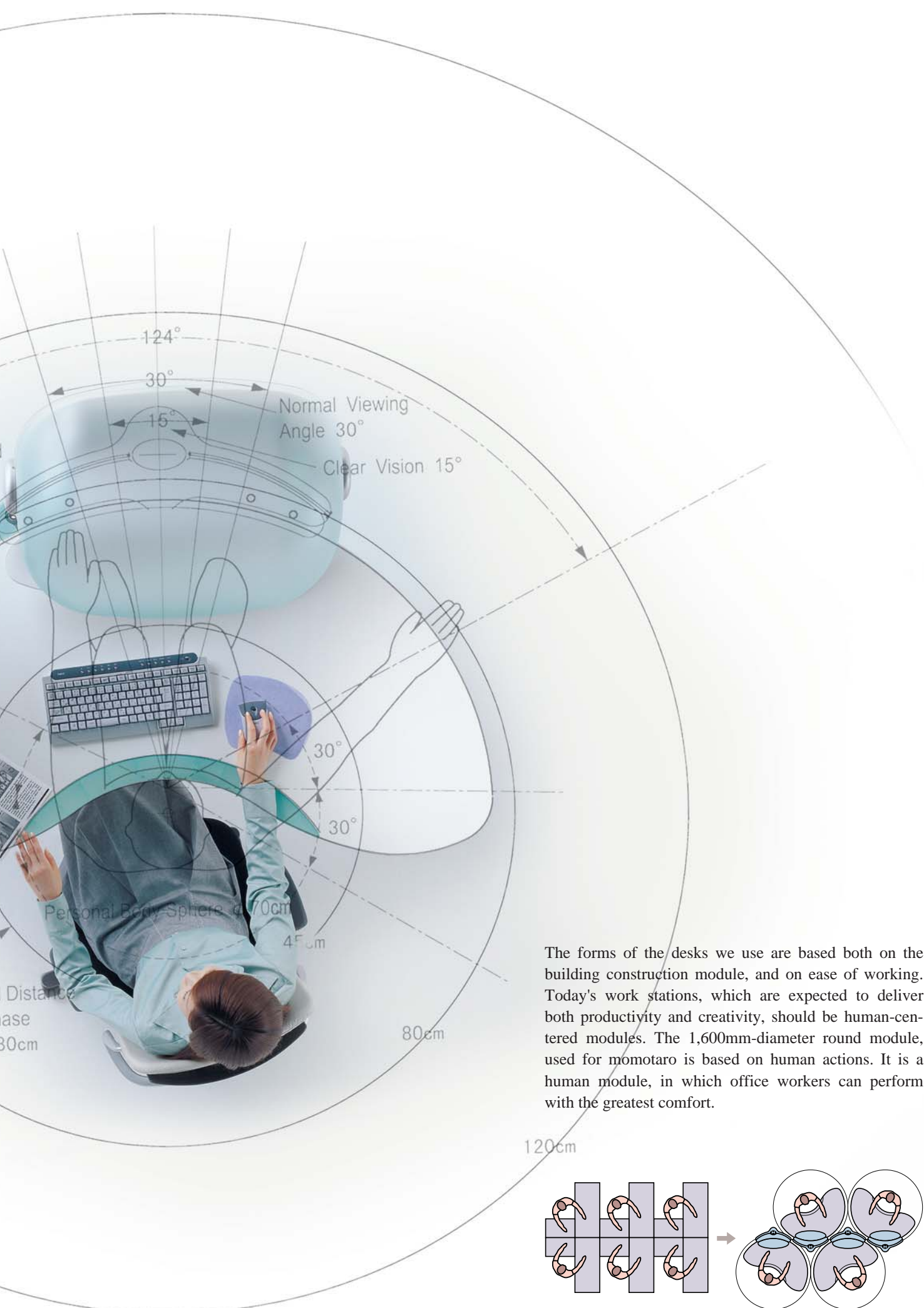

The forms of the desks we use are based both on the building construction module, and on ease of working. Today's work stations, which are expected to deliver both productivity and creativity, should be human-centered modules. The 1,600mm-diameter round module, used for momotaro is based on human actions. It is a human module, in which office workers can perform with the greatest comfort.

120cm

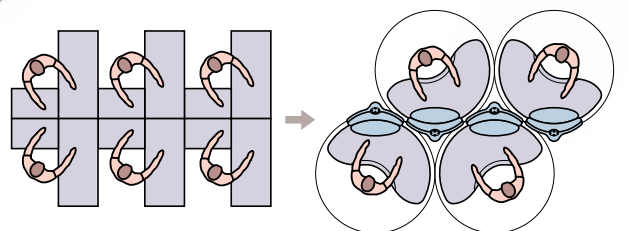

This desk has a top that rotates through 60 °
enabling instant changes of work mode





The top of the desktop can rotate 30° to right and left to instantly change the office worker's point of view and broaden his or her field of view. Rotation facilitates switches between work modes, stimulates inspiration and enhances creative work.

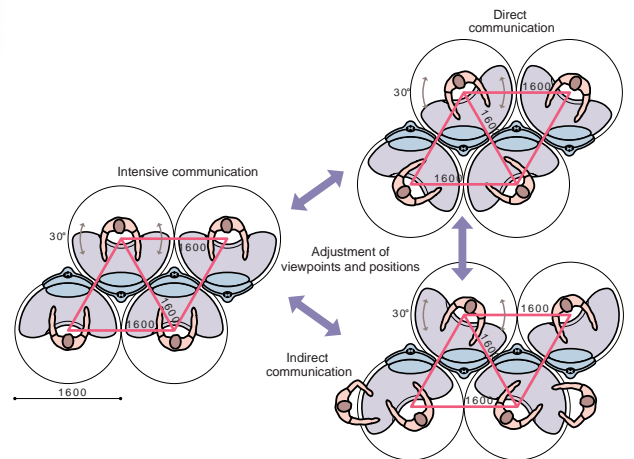

A distance between every two workers is always kept constant at 1,600mm. The new structure offers more comfortable working environments to office workers.

The cockpit station is ready for serious digital work





Space is rendered three dimensionally in this advanced function work station, giving the immediate visual comprehension that is essential for digital work, and the compact design puts everything within reach of the seated worker.

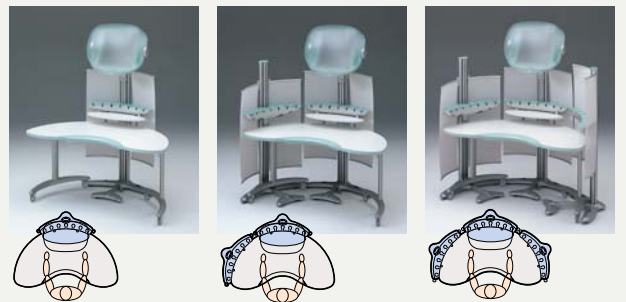
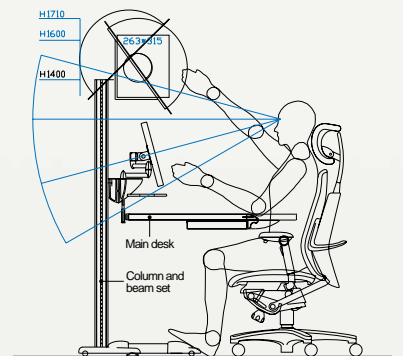

Depending on work style requirement, the function of the desk can be enriched by simply adding more column and beam sets and available optional tools.

The round module creates efficient and flexible layout





Compared to a square-based desk, a round desk avoids wasted corners, delivering more efficient use of office space. A circular desk also enables free settings to match new organizational forms.



Round shape is efficient.

Imagine that beads and dice of equal size, they are to fill the same bottle one at a time. Which can be more in the bottle? Bead is a winner. Likewise, the combination of round desks is efficient in avoiding waste space.

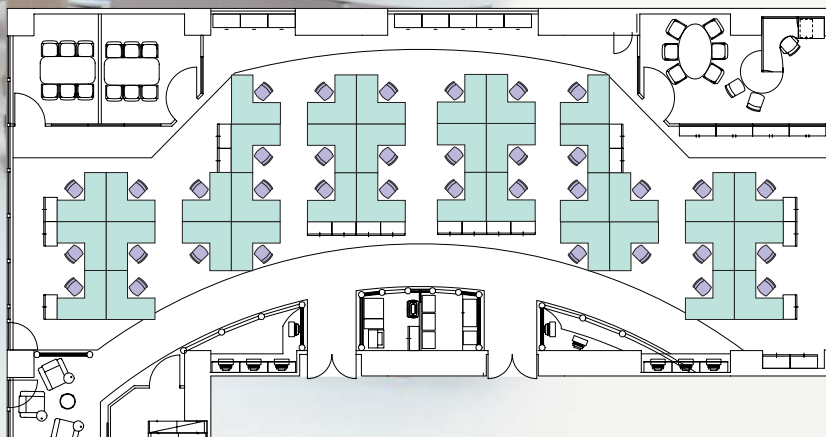

Office plan adopting L type desks
Office area : 216m²
Number of seats : 36
Occupied area : 6m²/person

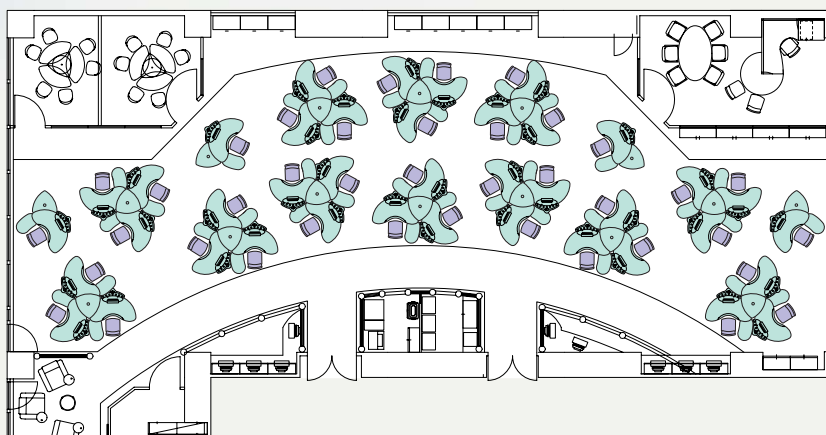
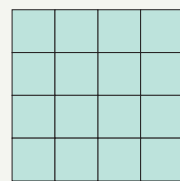

Office plan adopting momotaro desks
Office area : 216m²
Number of seats : 40
Occupied area : 5.4m²/person

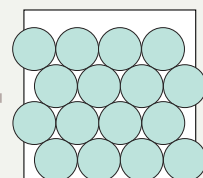

Comfort and ease of use in every aspect



Ambient light

Installed behind the upper cabinet, this light gives your office an active lighting change when you open or close the cabinet cover.

Upper cabinet

With easy open/close cover, this cabinet allows a seated worker to make smooth access to documents.

Main Column

Has a feature of fitting various options and wiring ducts.

Center drawer

This drawer can receive from small objects to A3 size paper.

Desk edge

Cubic surface design gives gentle and smooth touch.

Foot-rest

Provides worker an additional seating comfort.

Desk caster

By unlocking this caster, the desk can be easily moved as required.

LCD monitor arm

This flexible monitor arm keeps your viewing distance at its ideal level.

Desk screen

With easy height adjustment system, this translucent screen helps workers to share light and space.

Vertical wiring column

Receives vertical wirings neatly (with clips).

Adjustment of desk height

Adjustable in a range from 680 to 780mm.

Rotatable CPU holder

Makes effective use of foot space. This holder can be pulled out toward you for use.

Castor locking button

Basic columns are equipped with casters for ease of use. When basic columns are installed to desk, use this button to lock casters.

The momotaro workstation is the easiest to use, the most comfortable and the friendliest to the earth, thus realizing the "Ud & Eco style" concept within Itoki's theme of "creating environments that are friendly to people and the environment". It is adjustable to suit people's individual dimensions and the ways they work, achieving a high level of universal design. It also pursues ecology from many aspects, within a single design.



The lightly movable castors cope with any change in layout in your office.



The desk height can be adjusted as required.

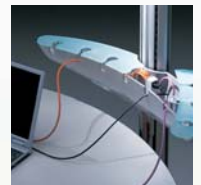

This cable management feature can cope with diversified needs for IT technology.

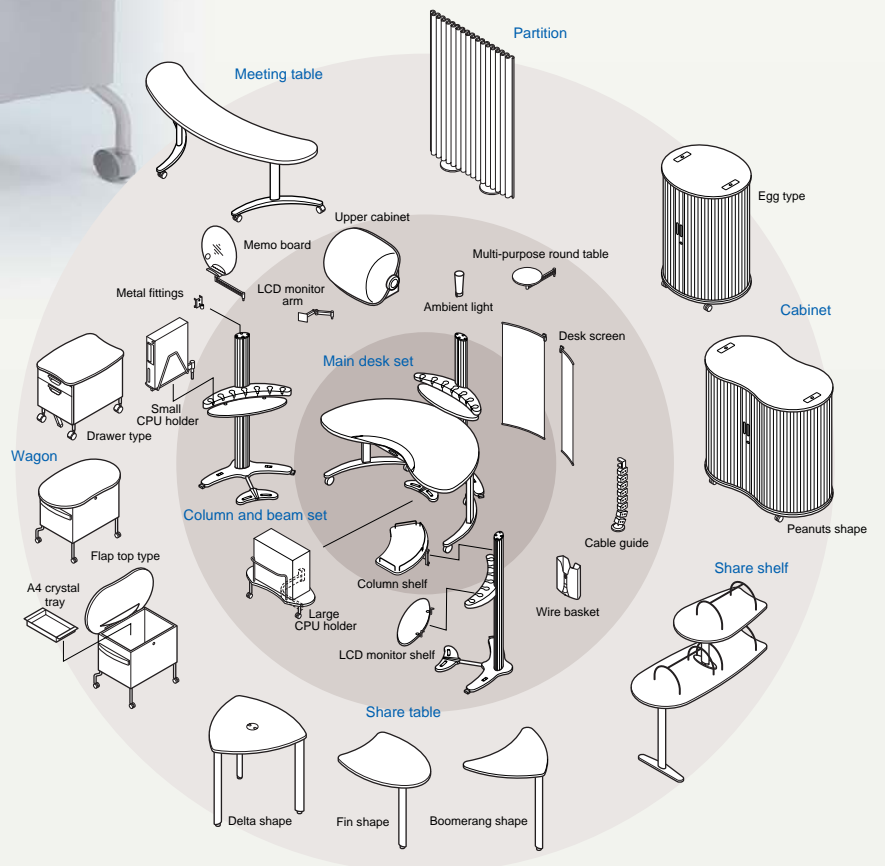

Basic Set



Main desk set
JJS-MDK-W9
 (with center drawer)
JJS-SDK-W9
 (without center drawer)
 Desk height: 680, 700, 720, 740, 760, 780
 Column and beam set (with LCD monitor shelf) and main desk
 Main desk turns to both sides around the column (up to 30 degree).

Desktop color : Melamine decorated plate MF
 W9
 White
 (Glass fiber handle)

Desktop edge color : Semi-transparent resin
 Aqua green

Body color : Melamine baked resin
 Z5
 Metallic silver

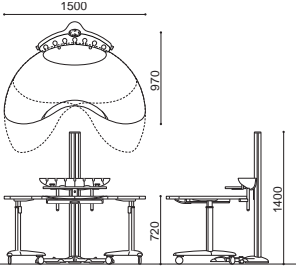

Center drawer
 W600 x H43
JJA-5100
 Inner sizes: W574 x D306 x H30
 This center drawer can accommodate small objects, A3 files and A4 note (thickness: 30mm or less)

Column and beam

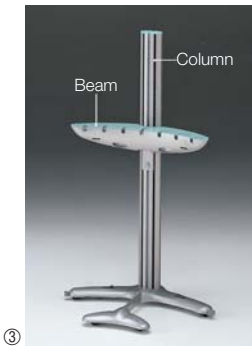

Column and beam set
 W834 x D615 x H1400 (beam height : H910)
JJ-14MSC-Z5 (with LCD monitor shelf)
JJ-14SSC-Z5 (without LCD monitor shelf)
 Thin castor with adjustor and castor lock

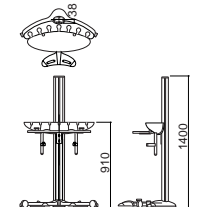

JJ-14MSC-Z5

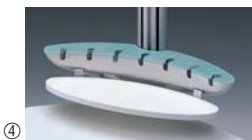

LCD monitor shelf
 Also used as a regular shelf. The height can be adjusted to two levels (820 or 910).



Basic column
 W834 x D615 x H1400
JJP-14SSC-Z5
 Thin castor with adjustor and castor lock

Column options



Desk screen:
 W360 x H950
 One set (two screens, one screen on each side)
 (set:W752 x H1000~1300)
Fabric (FF): JJ-0410SF-
Fabric (FA): JJ-0410SA-

Fabric chart indicates the transparency
 Fabric (FF): 100% polyester



Regenerated fabric (FA): 60% regenerated polyester, 40% polyester40%

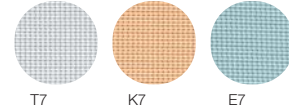

JJ-0410SA-K7



Upper cabinet (for column and beam set)
 W676 x D434 x H500
 (When mounted on column top: H1777)
JJ-064H-E7
 Steel, acrylic resin/volume : A4 box type 0.4 t/m
 CD pocket: inner dimensions W46 x 2, about 8 CD cases receivable
 Cover: rotational open/close, with down damper and key lock

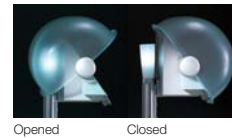

Opened Closed



Ambient light
 φ90 x H290
JJA-ABL-01
 AC 100V, 7W compact fluorescent lamp (luminosity equivalent to 30W), lamp color
 Code length: 150 cm
 Japanese-paper type acrylic shade



Large CPU holder (rotatable)
JJA-PCT01-W9



Example of the holder used



Column shelf
JJA-BS01-W9



Wire basket
 W300 x D82 x H300
JJA-33WB-Z5



Example of basket used:
 This basket can receive superfluous cable or OA tap.



Tap hanger
JJA-20TA-Z5



Example of hanger used:
 An OA tap can be hung onto this hanger.



Base wiring guide
JJA-BAW



Example of base wiring guide used:
 Guides floor wirings between columns.



Cable guide
JJA-07CW-CW



White board
 W1100 x t20 x H800
JJA-118WB
 One set



Metal fittings
JJA-PP01-Z5
 Used to fit beam options to the column.

Beam Options



17 **Memo board (marker board)**
Board: W550 x D360
Arm: L300
JJA-36MB-CL
Mirror attached on both sides, white/yellow markers, and eraser

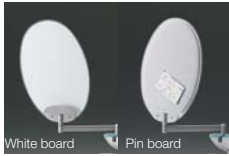

18 **Small white & pin board**
Board: W550 x D360
Arm: L300
JJA-36WB-T6
The backside of the white board is covered with fabric (pins can be used).



19 **Power supply plug**
JJA-20EP-CW
AC 100V, two plugs with 2P ground

Modular jack unit
JJA-30MJ-CW
This plug can receive two modular jacks (modular jacks on sale separately).



20 **Multi-purpose round table**
Desktop: ϕ 300 x t20
Arm: L300
JJA-30CA-W9



21 **LCD monitor arm (Three-point vertical control)**
JJA-LA21
This arm holds a LCD monitor, size up to 15-inch (approximately 5kg or less, 65mm or less in thickness). Mount specification: 75 x 75 VESA



22 **Small CPU holder (rotatable)**
JJA-PCT03-Z5



Example of the holder used
CPU size: must be W280 x D99 x H299 or less

Share Shelf Never fail to connect any type of shelf with column for use.



25 **2-shelf model (with small upper shelf)**
JJA-135WS-W9
Capacity: 0.4f/m x 6
Load capacity: 60kg (lower shelf), 30kg (upper shelf)

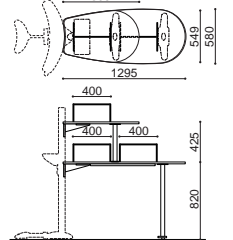

26 **2-shelf model**
JJA-135WW-W9
Capacity: 0.4f/m x 8
Load capacity: 30kg for upper step, 60kg for lower step

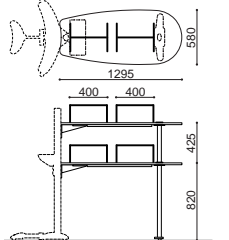

27 **Single shelf model**
JJA-105W-W9
Capacity: 0.4f/m x 4
Load capacity: 60kg

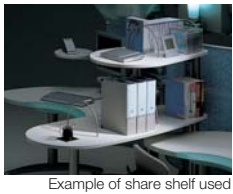
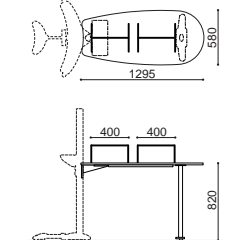

Example of share shelf used

Partition



31 **Panel screen**
W950 x H1400
JJ-0914AG-E7
Made of resin, two steel bases attached

Wagon



32 **Flap top type**
W770 x D450 x H582
JJ-057WNN-W9
0.5f/m with key lock and reading support stand



33 **Fixed-top type**
W770 x D450 x H582
JJ-057MG-W9
Drawer (pen tray) attached.
Inner size: 0.5 f/m



34 **Fixed-top, drawer type**
W500 x D654 x H582
JJ-057MF-W9
Key lock
Upper: drawer with pen tray
Lower: large drawer for A4 files (0.54 f/m)

Meeting Table

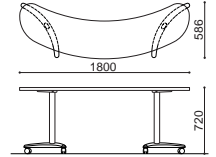

JJ-1847MT-W9

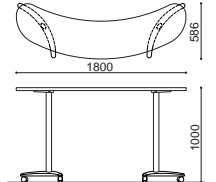

JJ-1840MT-W9

Share Table Never fail to connect a boomerang or fin shape table with column for use.

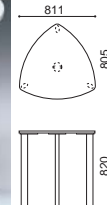

28 **Delta shape**
JJ-SST01-W9



Example of the table used

Dedicated wire receptacle JJA-CDR

A wire receptacle can be fitted to a regular model to receive superfluous cord.

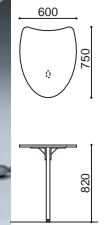

29 **Fin shape**
JJ-ST02-W9

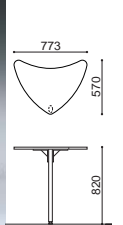

30 **Boomerang shape**
JJ-ST01-W9

Cabinet



H 820 type (H813)
JJ-0811WNN-W9
Capacity: 1.72 f/m

H1150 type (H1154)
JJ-1111WNN-W9
Capacity: 2.58 f/m

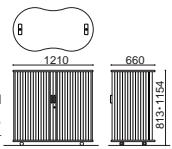

Translucent shutter (smoked glass color) with a key lock, side wiring duct, two caps for plug and castors.



H 820 type (H813)
JJ-0807WNN-W9
Capacity: 0.82 f/m

H1150 type (H1154)
JJ-1107WNN-W9
Capacity: 1.23 f/m

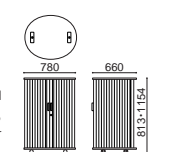

Translucent shutter (smoked glass color) with a key lock, side wiring duct, two caps for plug and castors.



Power supply plug
CZA-800
A power supply plug can be fitted to the top of cabinet
AC 100V

Contact